

LINE 01

NORTH/EAST CORNER

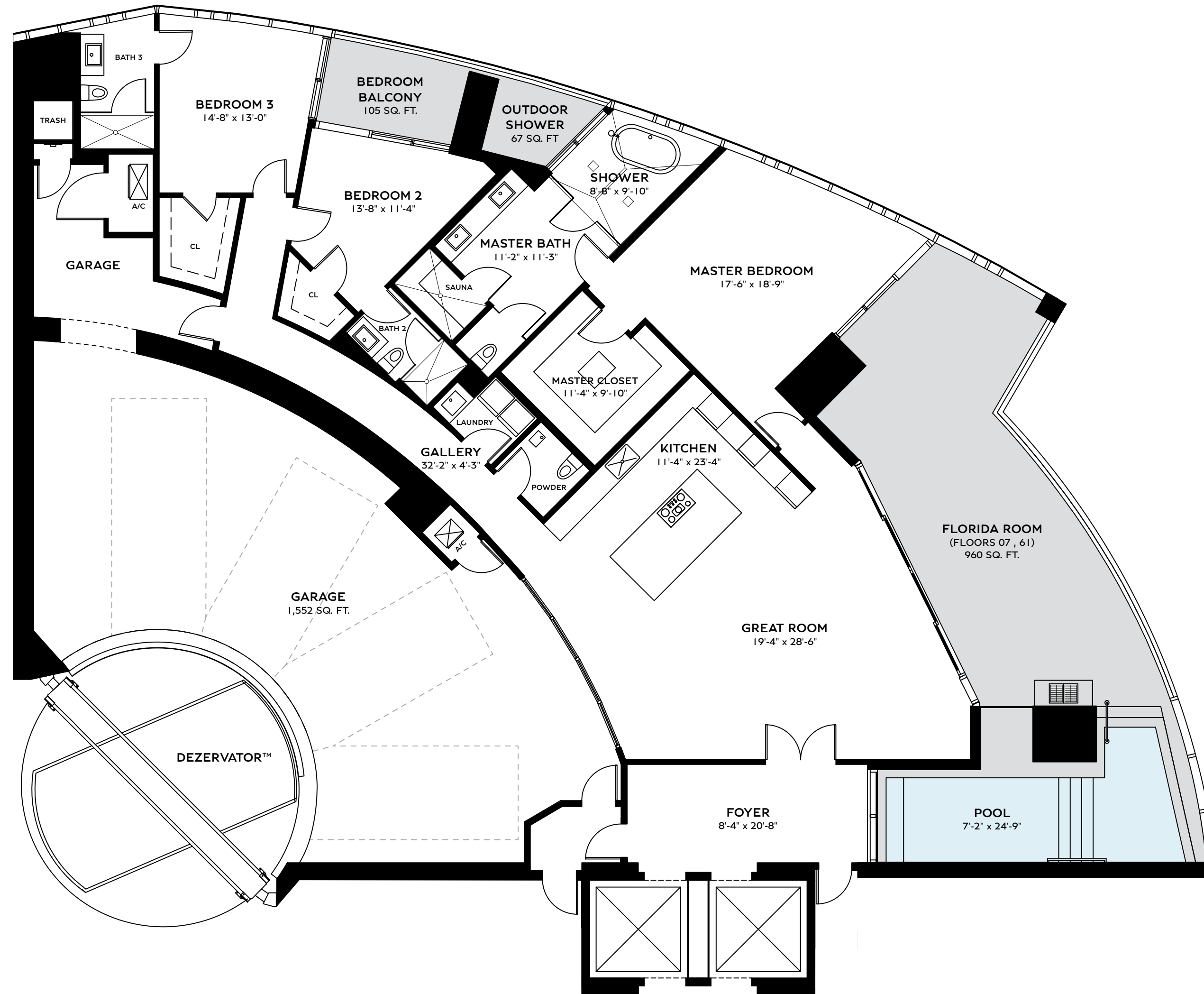
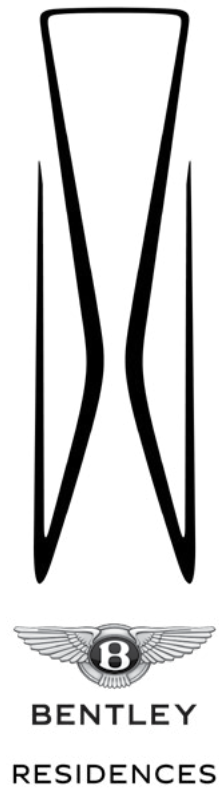

LINE 01
RESIDENCE ARNAGE
3 BEDS | 3.5 BATHS

FLOORS 07 , 61

INTERIOR	3,015 SQ. FT.	280.10 SQ. M.
BALCONY	1,132 SQ. FT.	105.17 SQ. M.
GARAGE	1,547 SQ. FT.	143.72 SQ. M.
TOTAL	5,694 SQ. FT.	528.99 SQ. M.

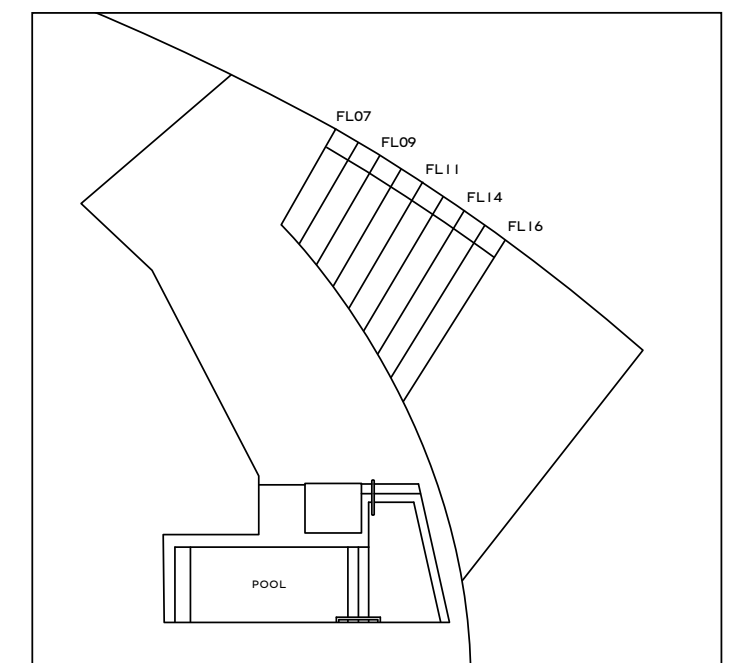
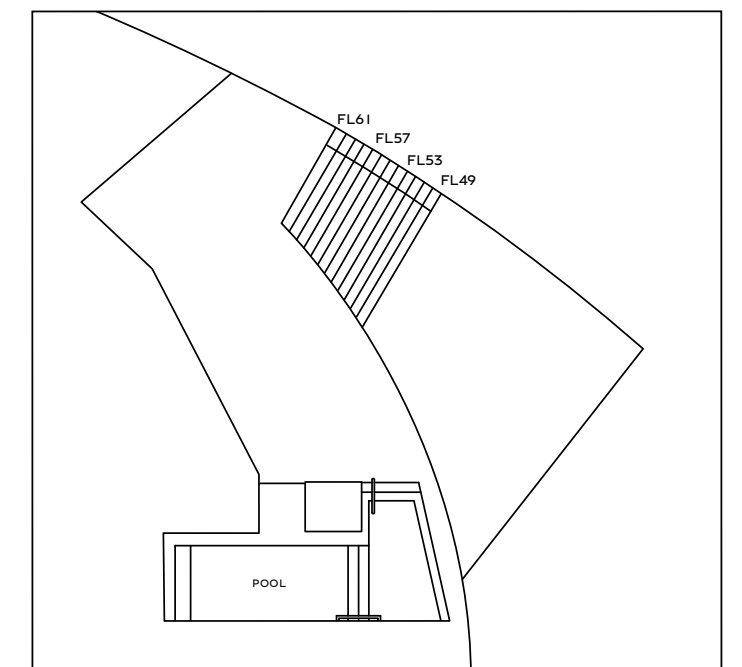

TERRACE AREA VARIES BY FLOOR

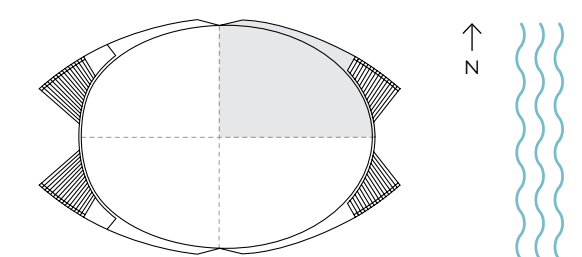

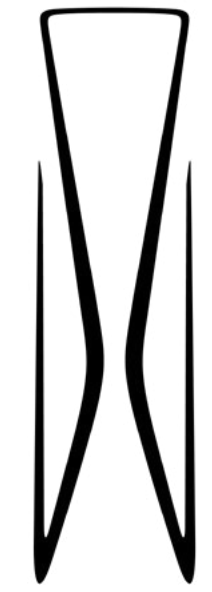

B
BENTLEY
RESIDENCES

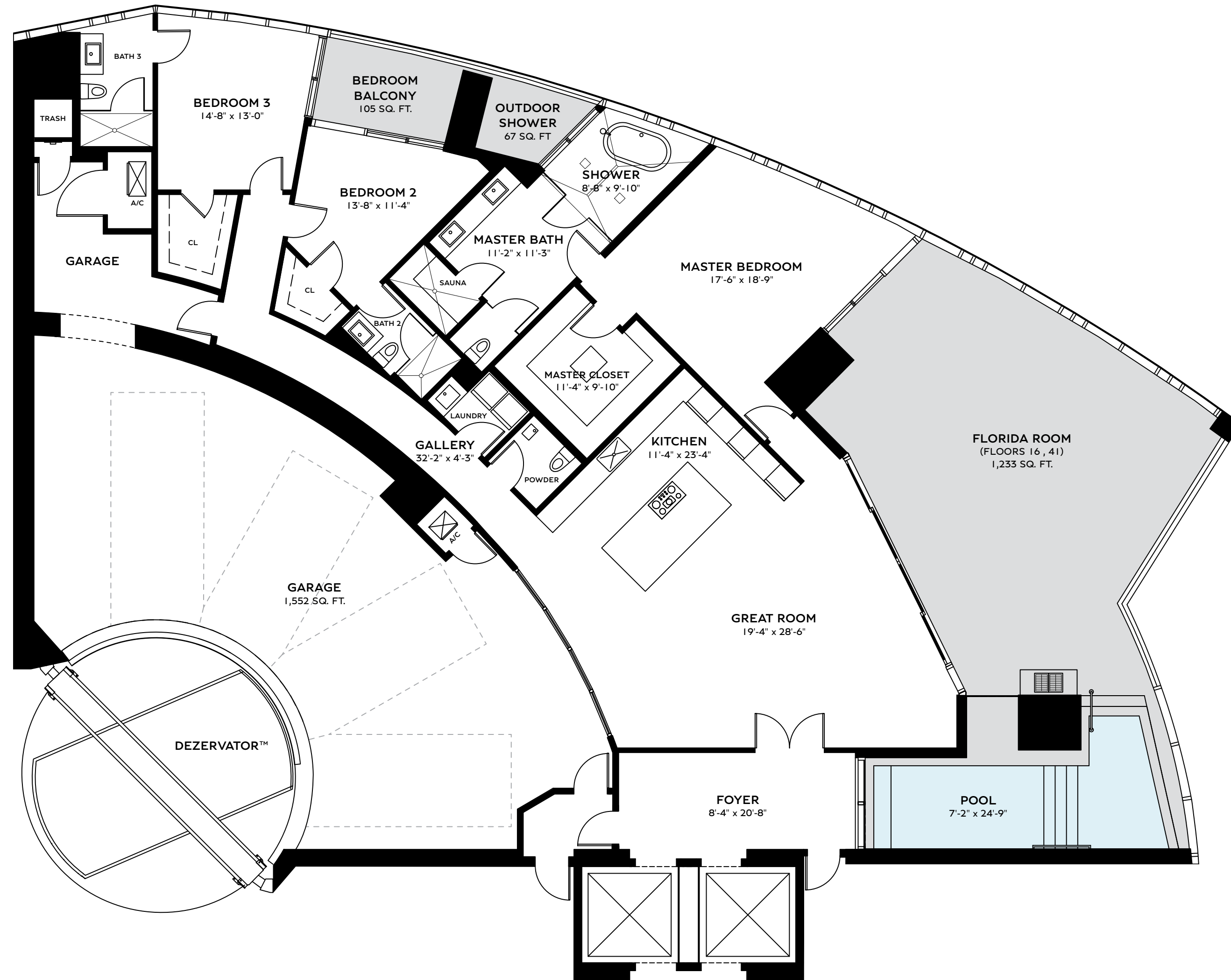

LINE 01
RESIDENCE ARRANGE
3 BEDS | 3.5 BATHS

FLOORS 16, 41

INTERIOR	3,015 SQ. FT.	280.10 SQ. M.
BALCONY	1,405 SQ. FT.	130.53 SQ. M.
GARAGE	1,547 SQ. FT.	143.72 SQ. M.
TOTAL	5,967 SQ. FT.	554.35 SQ. M.

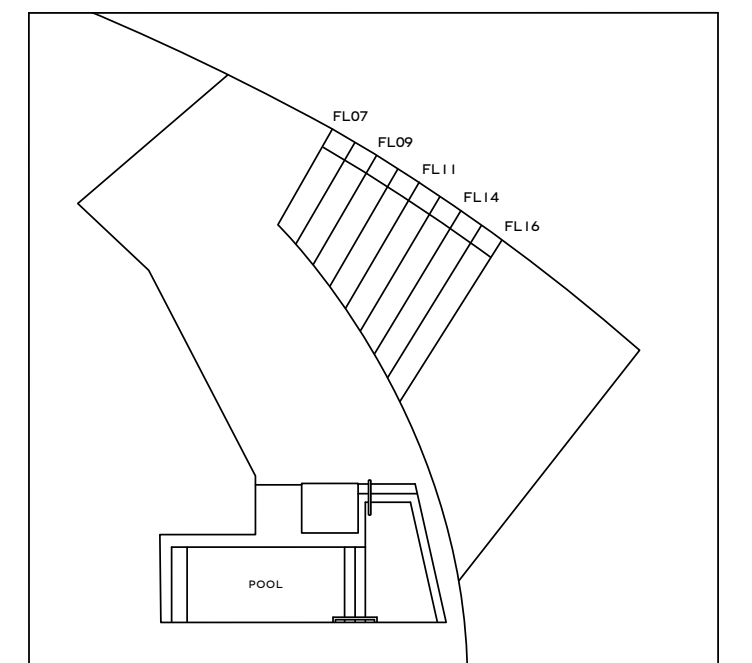
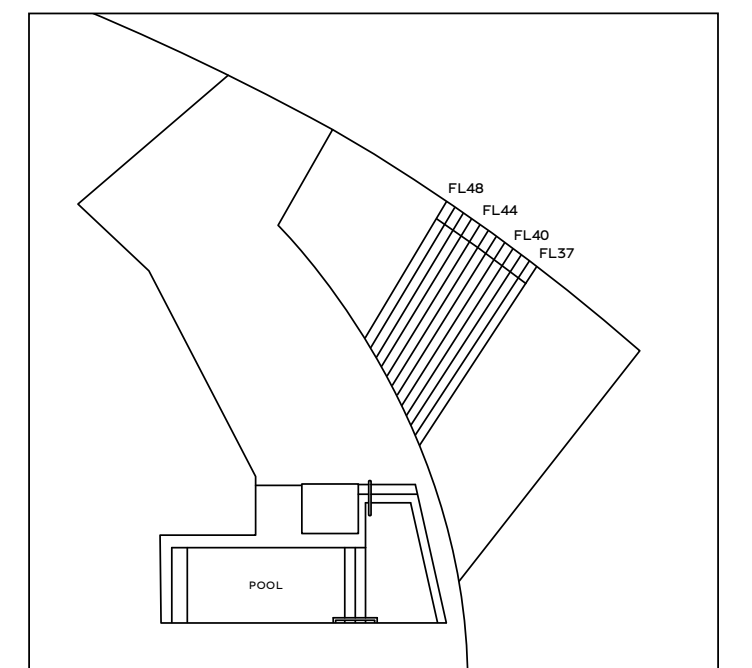

TERRACE AREA VARIES BY FLOOR

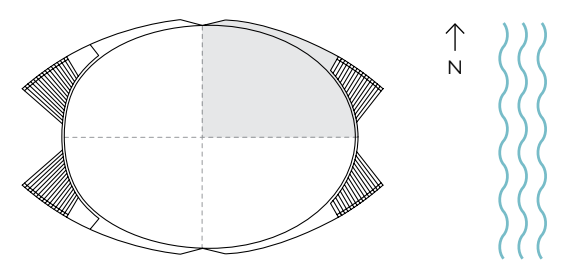

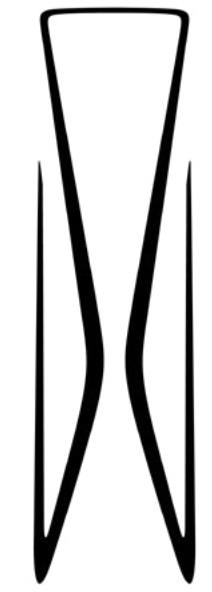

BENTLEY
RESIDENCES

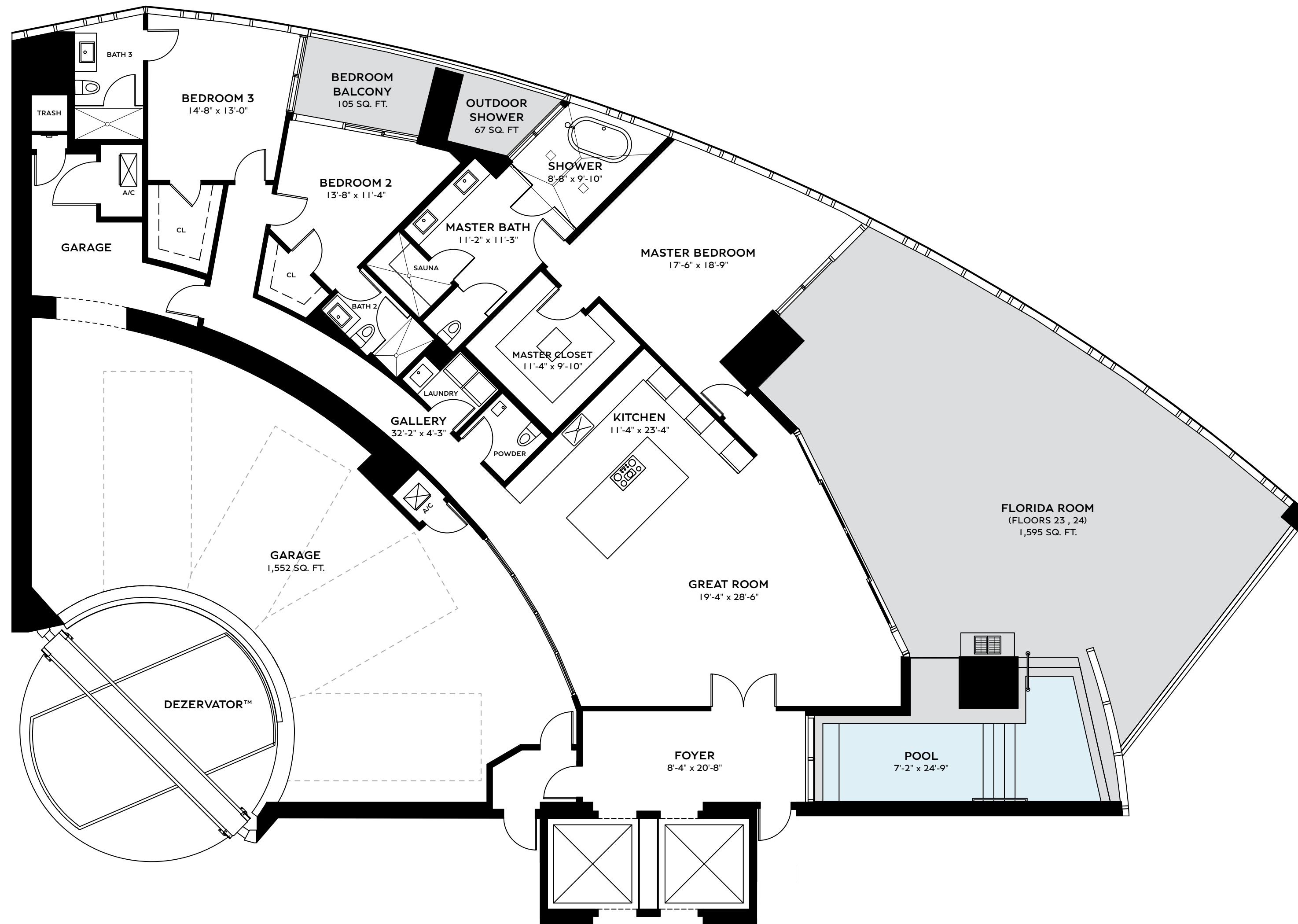

LINE 01
RESIDENCE ARRANGE
3 BEDS | 3.5 BATHS

FLOORS 23, 24

INTERIOR	3,015 SQ. FT.	280.10 SQ. M.
BALCONY	1,767 SQ. FT.	164.16 SQ. M.
GARAGE	1,547 SQ. FT.	143.72 SQ. M.
TOTAL	6,329 SQ. FT.	587.98 SQ. M.

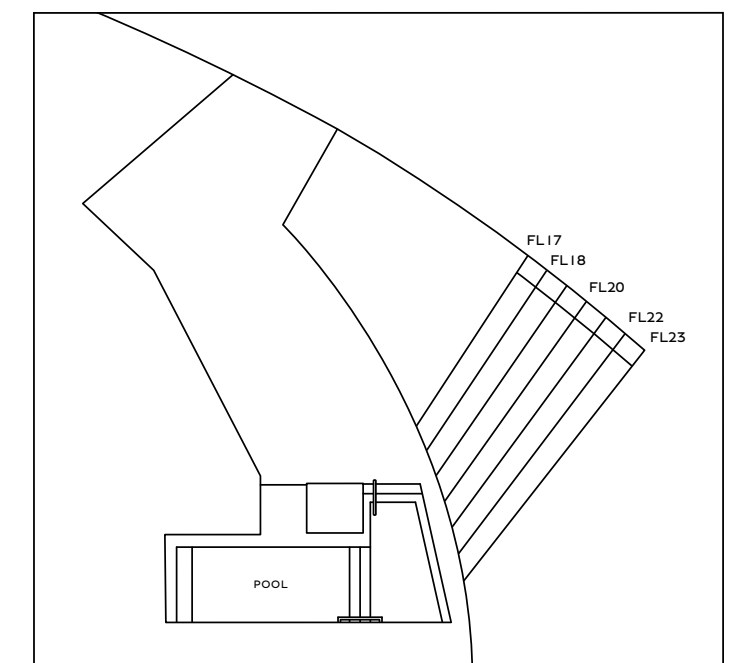
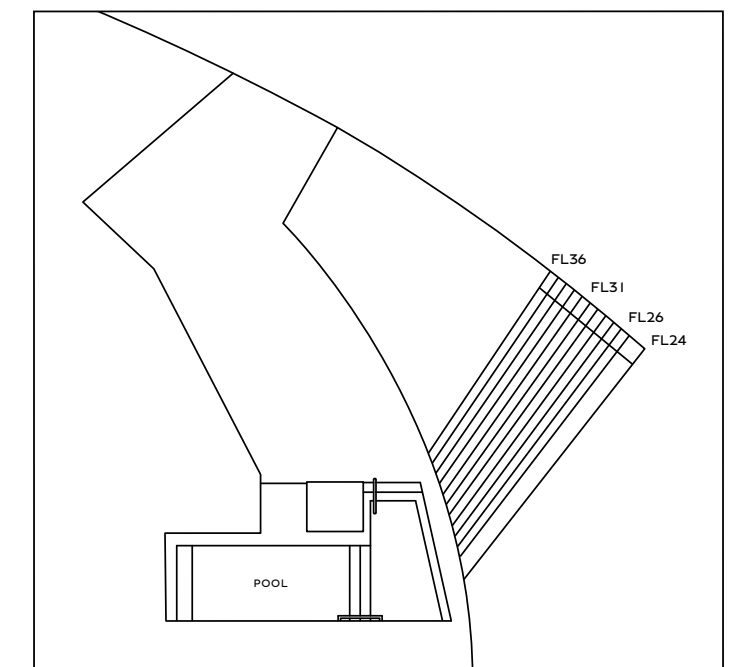

TERRACE AREA VARIES BY FLOOR

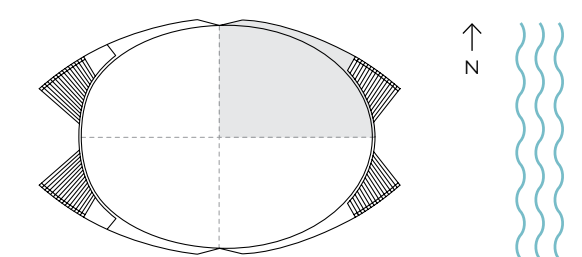

LINE 02

SOUTH/EAST CORNER

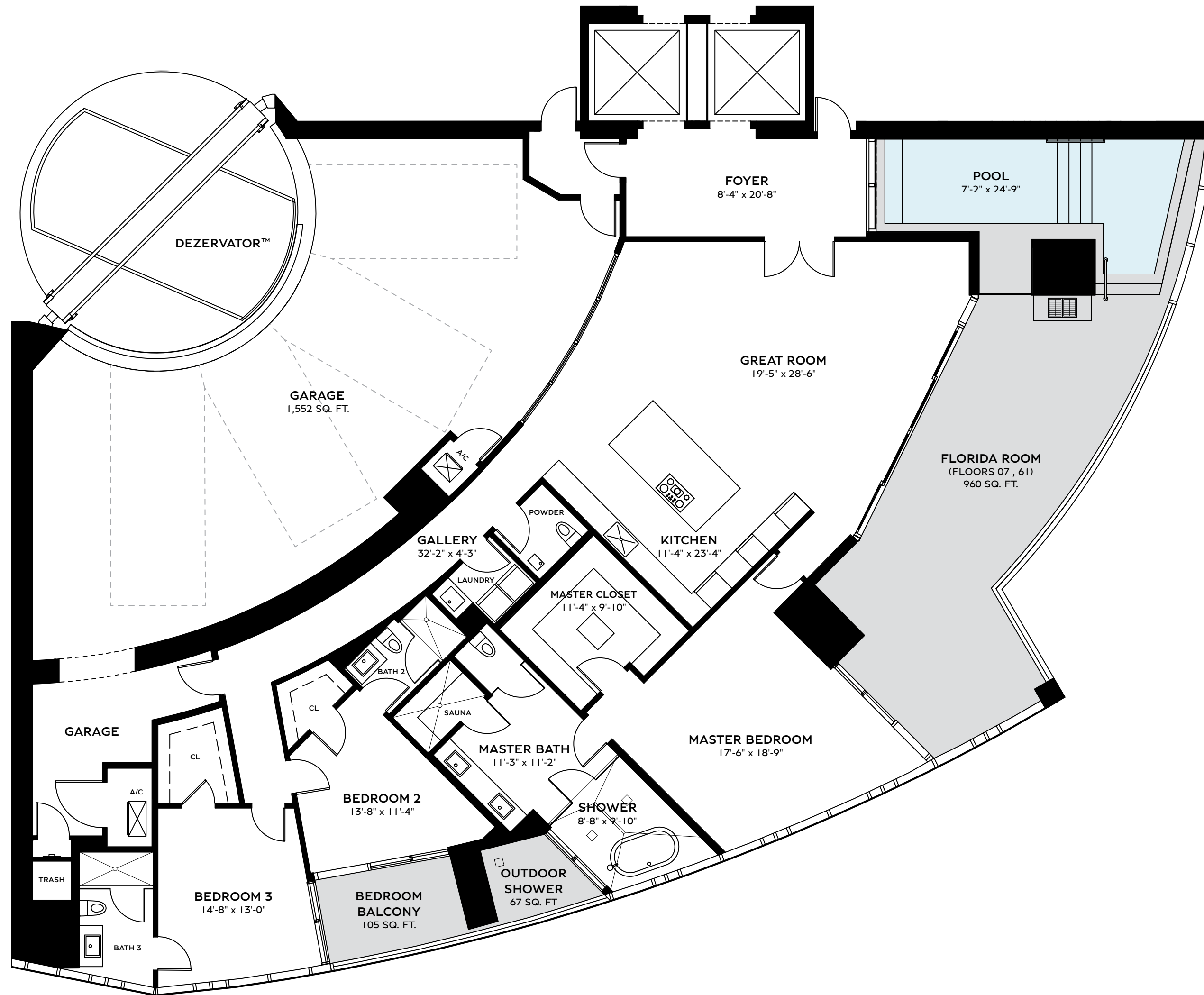
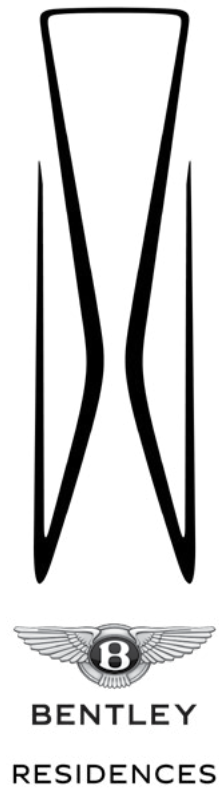

LINE 02
RESIDENCE AZURE
3 BEDS | 3.5 BATHS

FLOORS 07, 61

INTERIOR	3,015 SQ. FT.	280.10 SQ. M.
BALCONY	1,132 SQ. FT.	105.17 SQ. M.
GARAGE	1,547 SQ. FT.	143.72 SQ. M.
TOTAL	5,694 SQ. FT.	528.99 SQ. M.

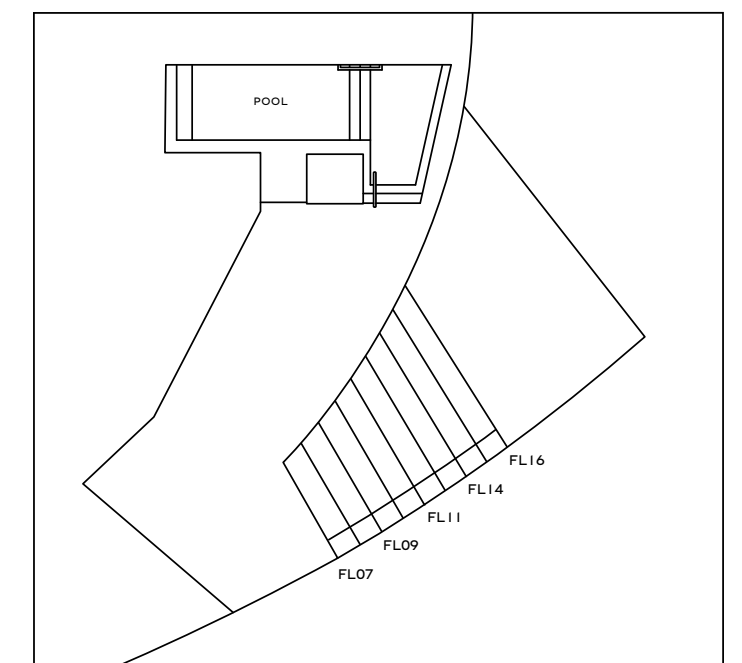
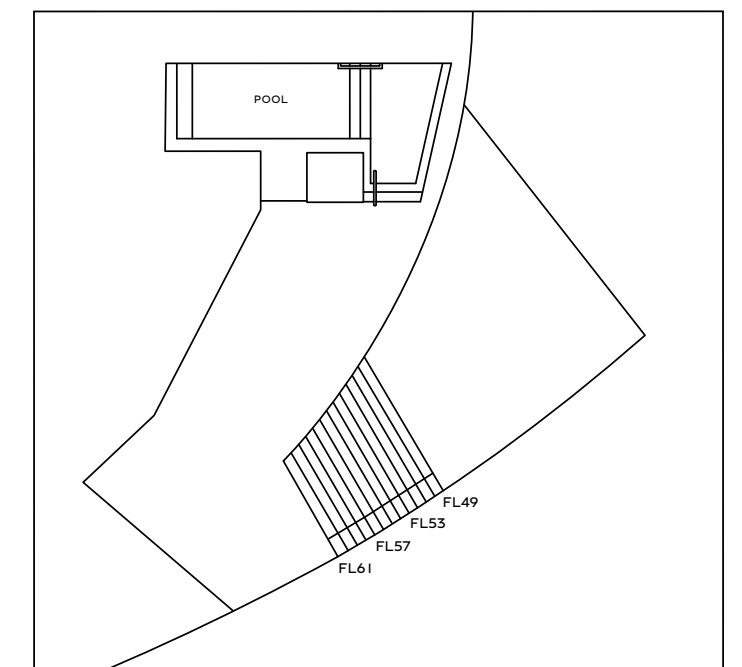

TERRACE AREA VARIES BY FLOOR

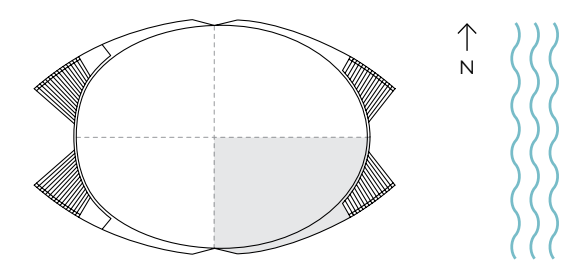

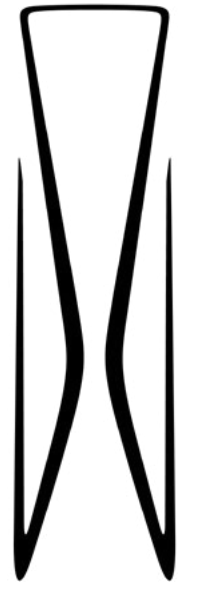

BENTLEY
RESIDENCES

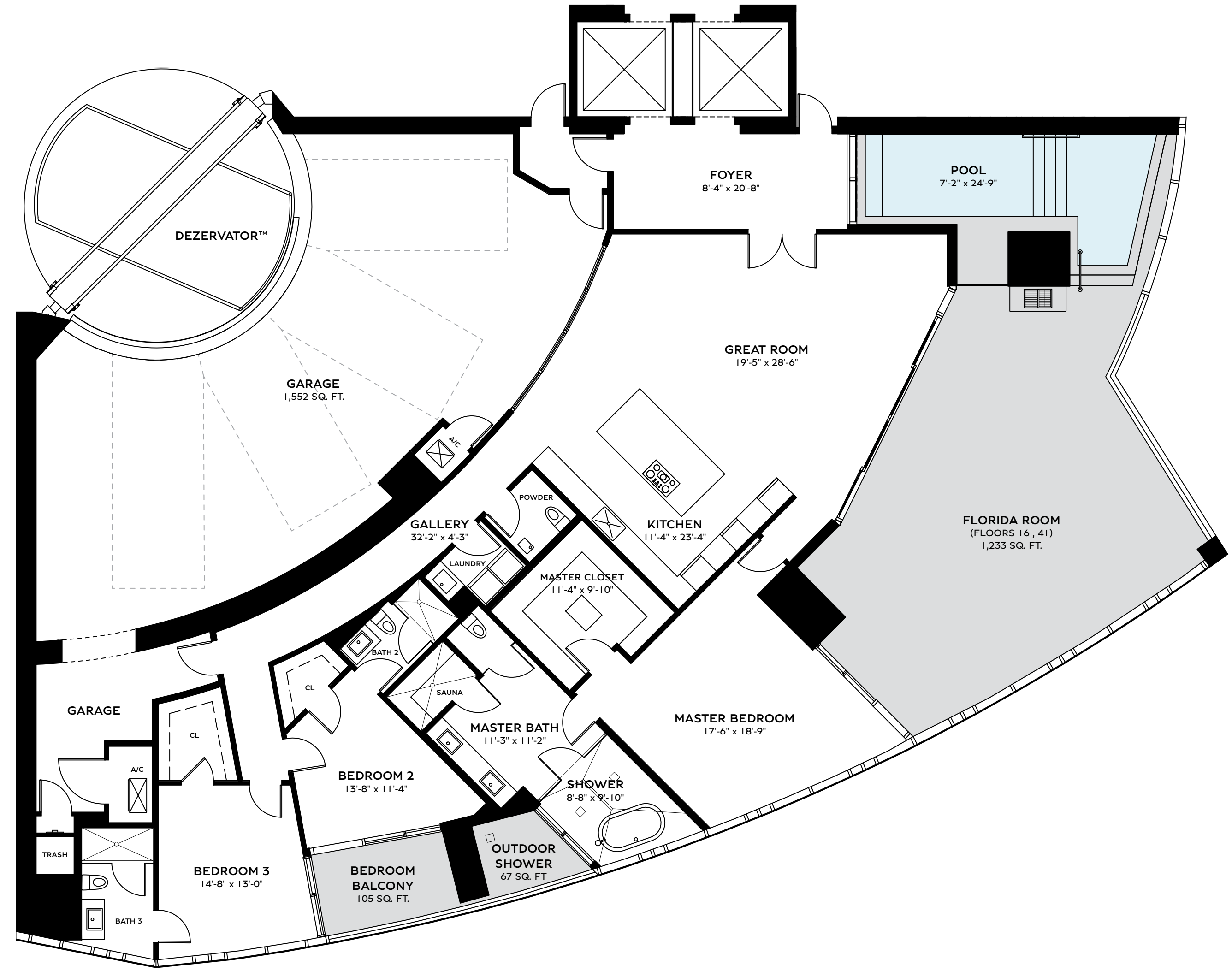

LINE 02
RESIDENCE AZURE
3 BEDS | 3.5 BATHS

FLOORS 16, 41

INTERIOR	3,015 SQ. FT.	280.10 SQ. M.
BALCONY	1,405 SQ. FT.	130.53 SQ. M.
GARAGE	1,547 SQ. FT.	143.72 SQ. M.
TOTAL	5,967 SQ. FT.	554.35 SQ. M.

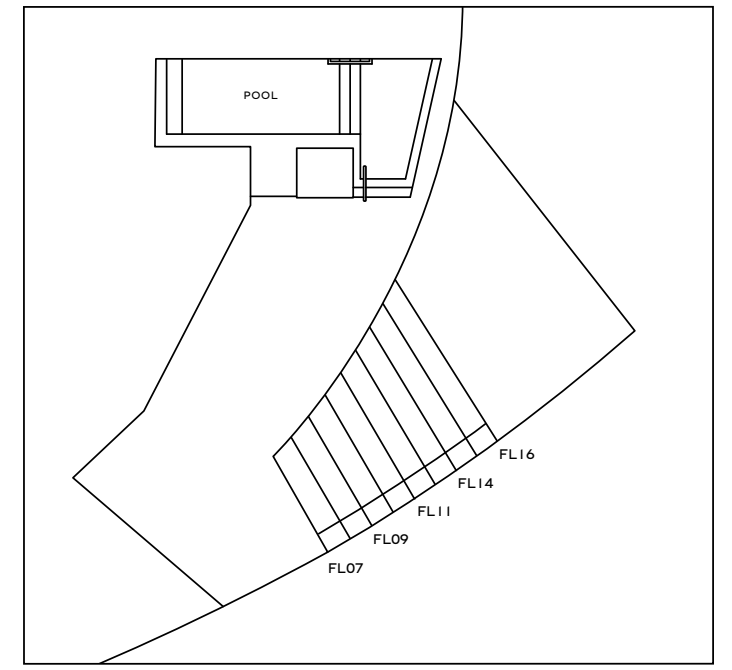
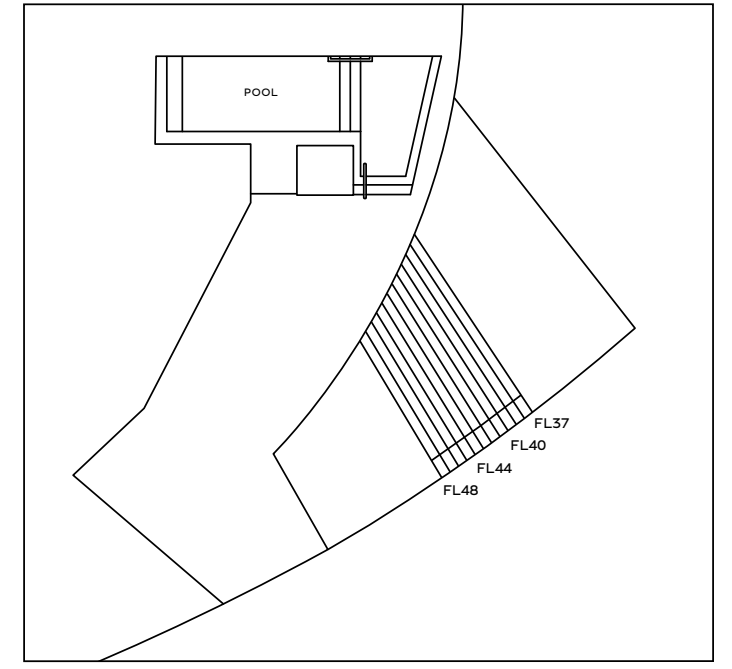

TERRACE AREA VARIES BY FLOOR

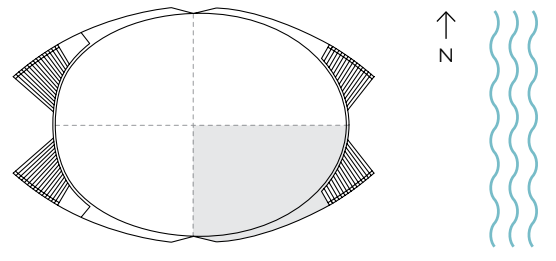

LINE 03

SOUTH/ EST CORNER

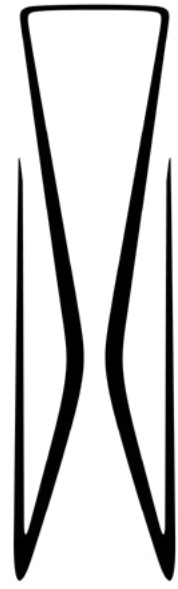

B
BENTLEY
RESIDENCES

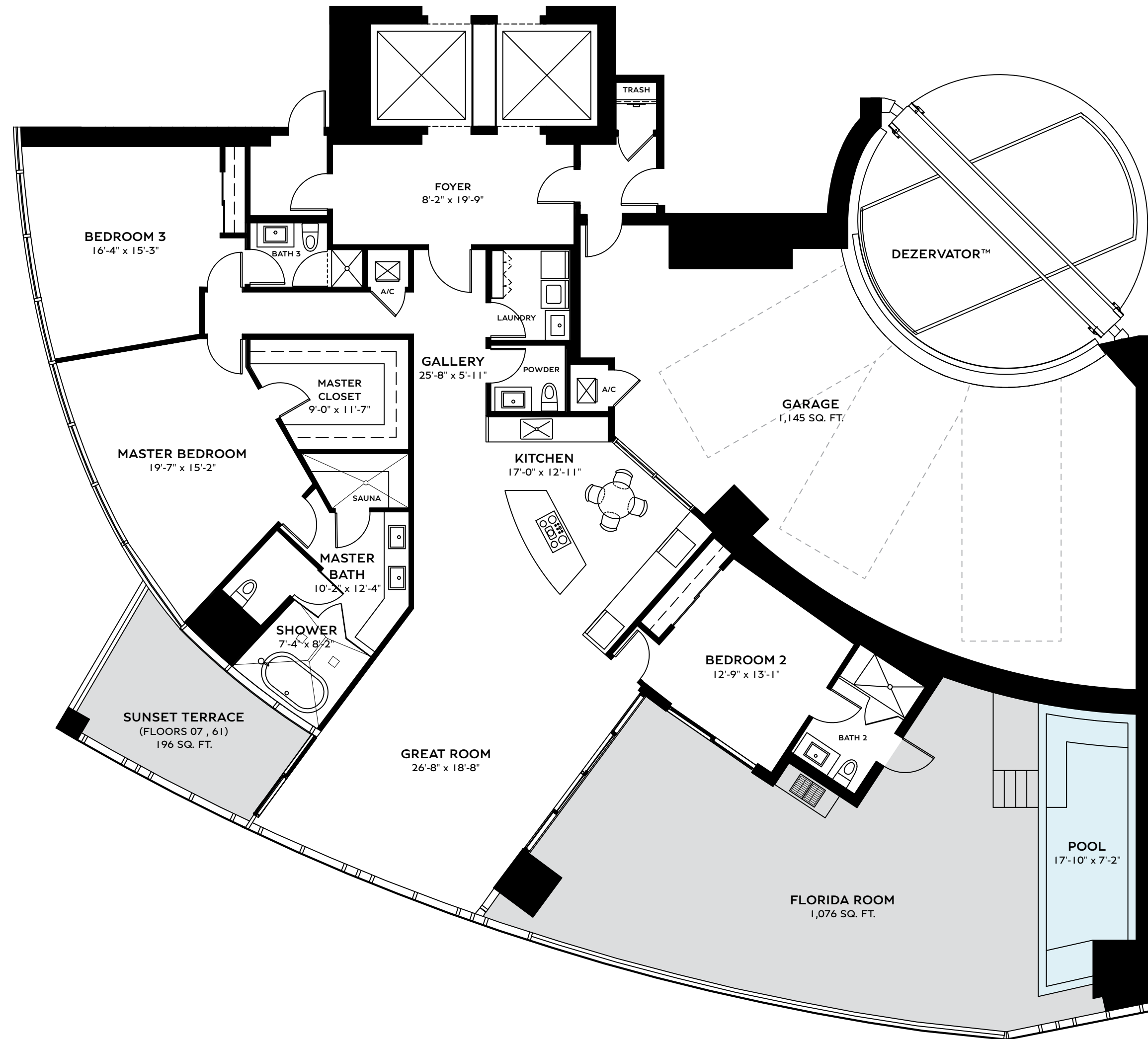

**LINE 03
RESIDENCE BENTAYGA
3 BEDS | 3.5 BATHS**

FLOORS 07 , 61

INTERIOR	2,835 SQ. FT.	263.38 SQ. M.
BALCONY	1,268 SQ. FT.	117.80 SQ. M.
GARAGE	1,146 SQ. FT.	106.47 SQ. M.
TOTAL	5,249 SQ. FT.	487.65 SQ. M.

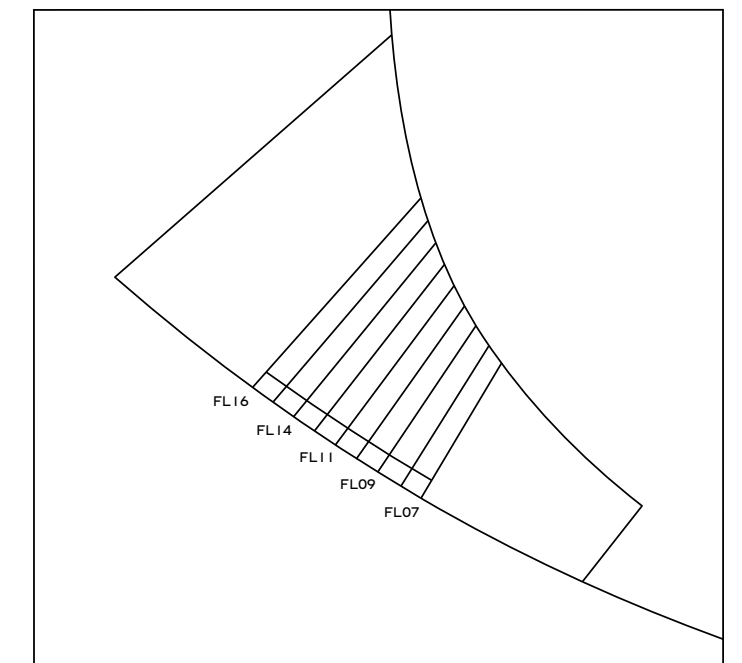
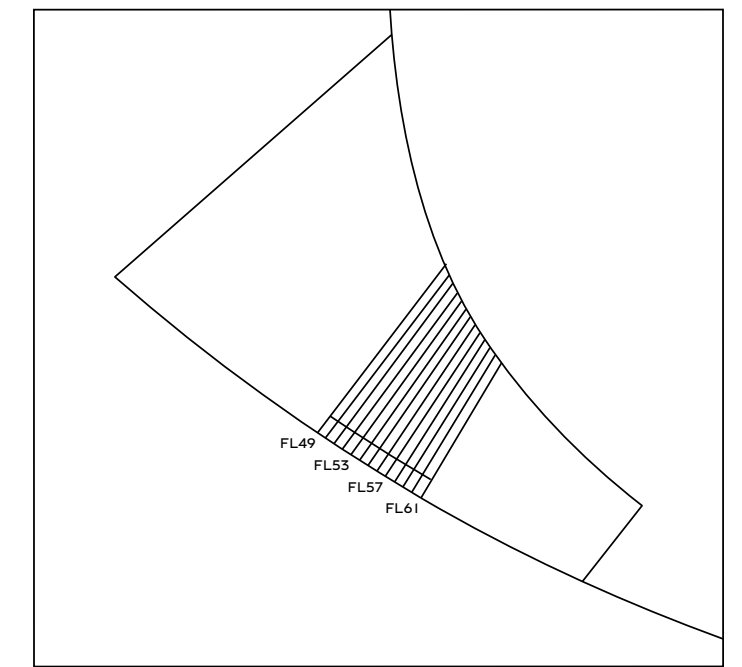

TERRACE AREA VARIES BY FLOOR

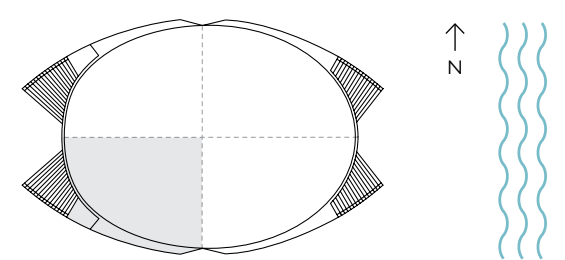

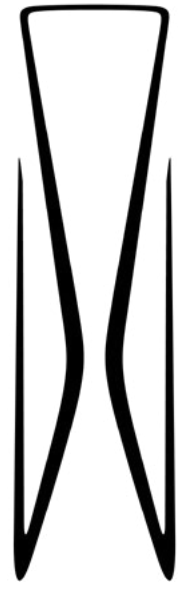

B
BENTLEY
RESIDENCES

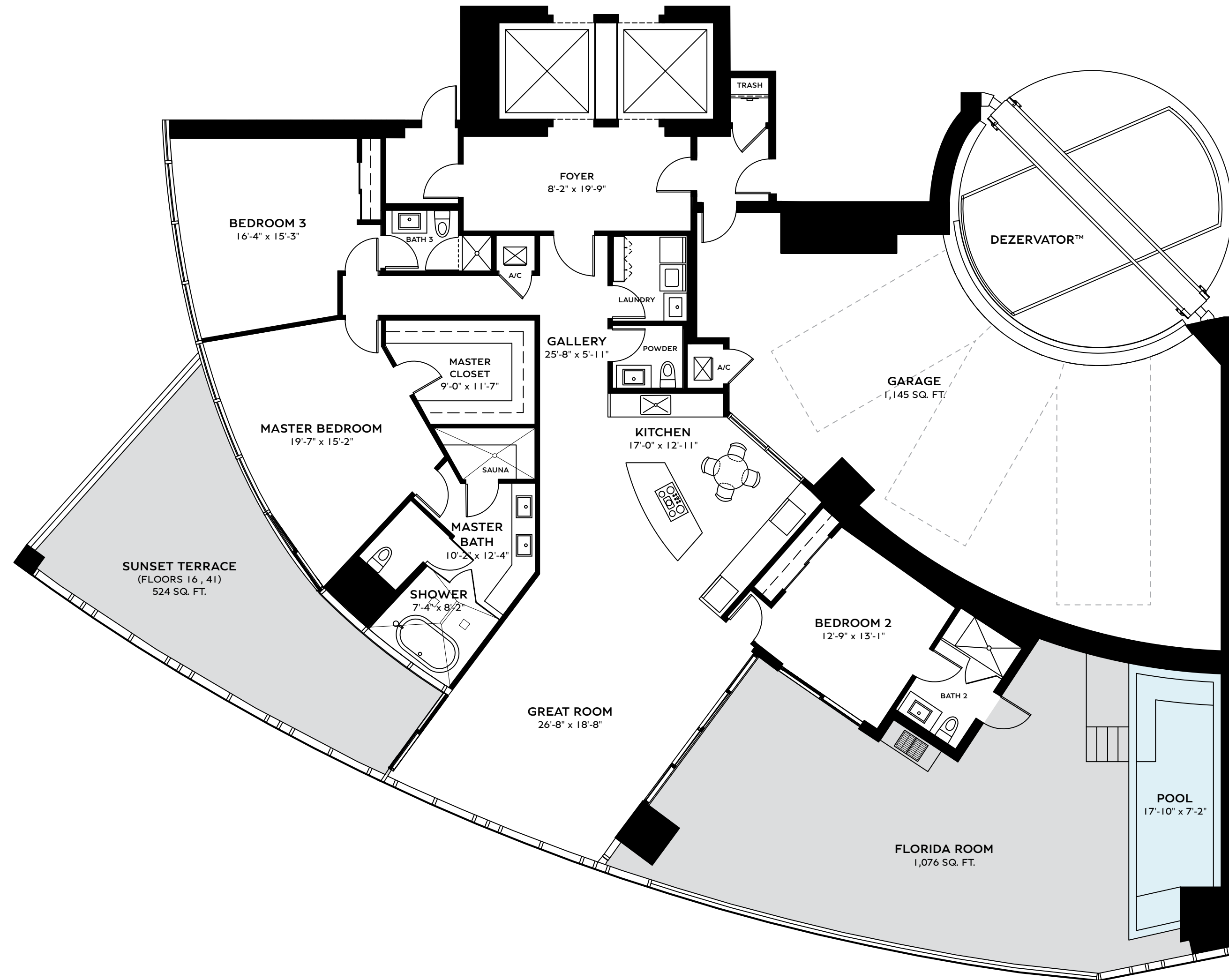

RESIDENCE BENTAYGA
3 BEDS | 3.5 BATHS

FLOORS 16, 41

INTERIOR	2,835 SQ. FT.	263.38 SQ. M.
BALCONY	1,596 SQ. FT.	148.27 SQ. M.
GARAGE	1,146 SQ. FT.	106.47 SQ. M.
TOTAL	5,577 SQ. FT.	518.12 SQ. M.

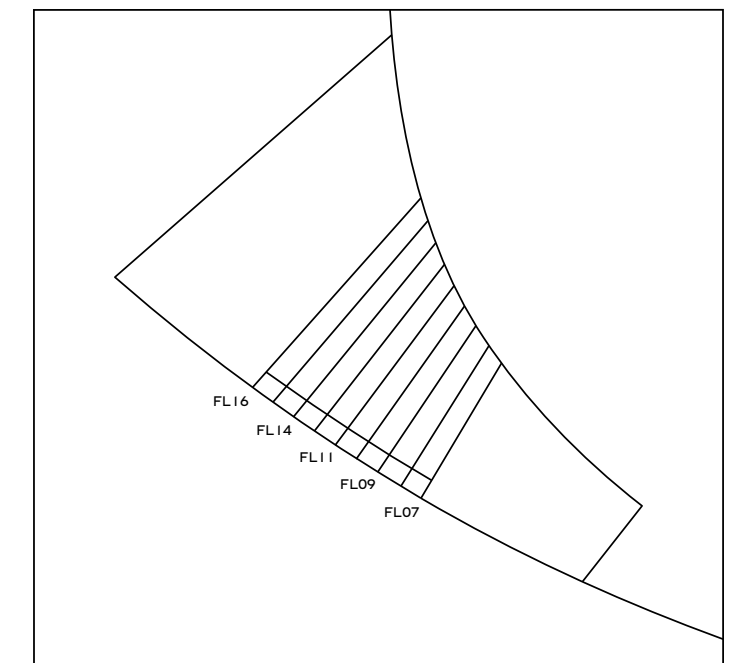
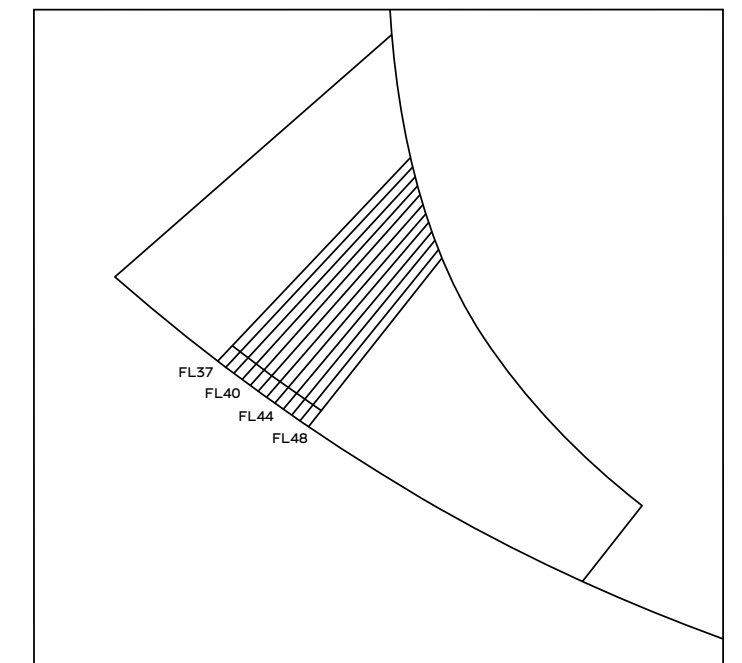

TERRACE AREA VARIES BY FLOOR

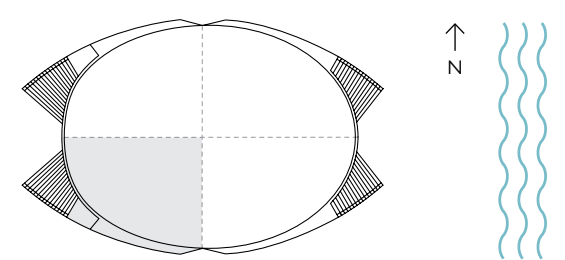

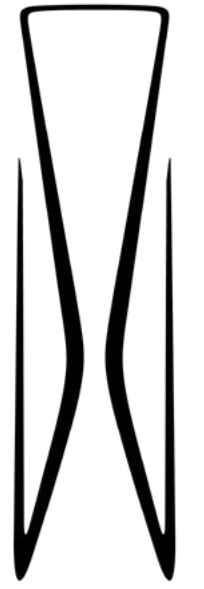

BENTLEY
RESIDENCES

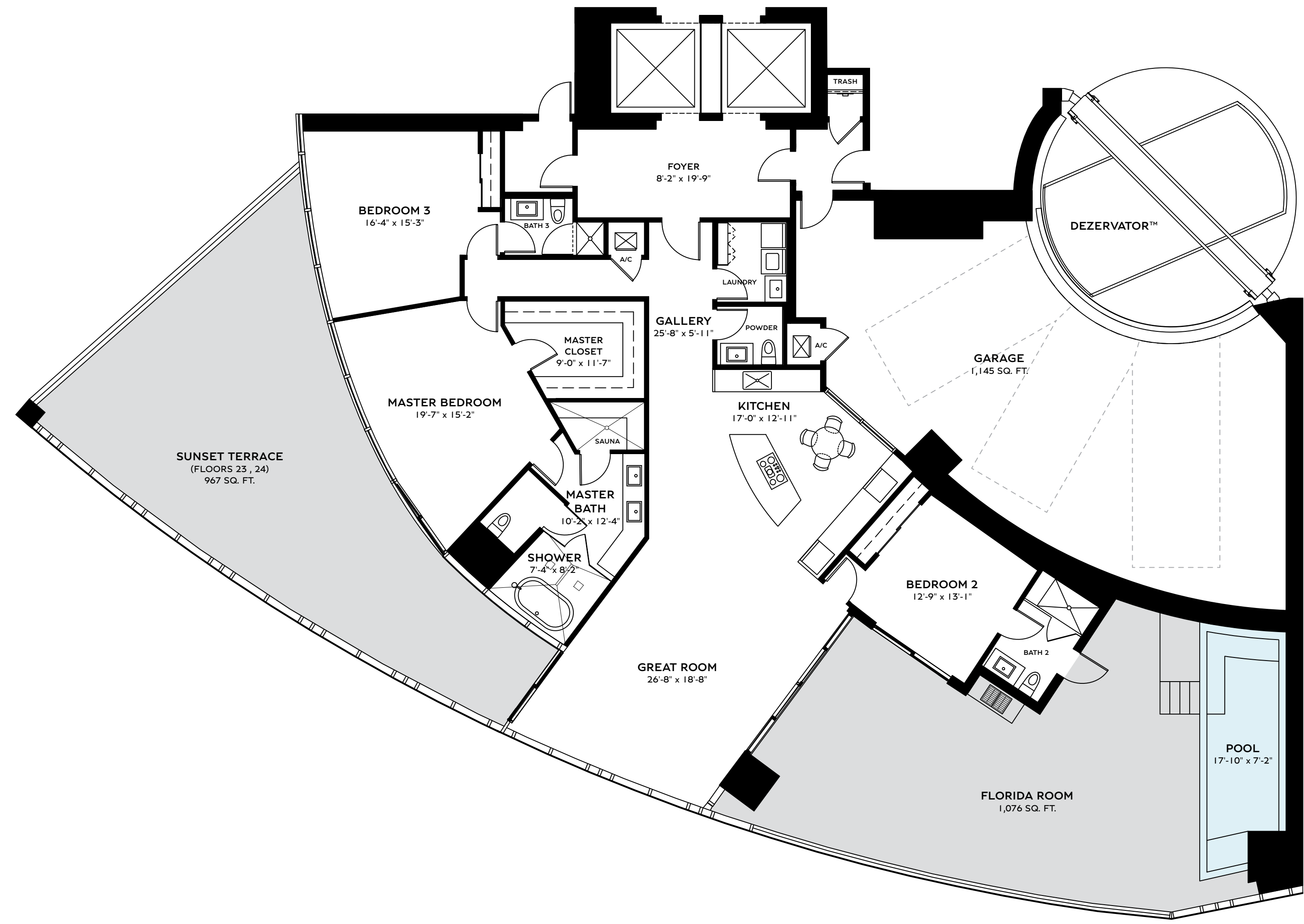

LINE 03
RESIDENCE BENTAYGA
3 BEDS | 3.5 BATHS

FLOORS 23 , 24

INTERIOR	2,835 SQ. FT.	263.38 SQ. M.
BALCONY	2,039 SQ. FT.	189.43 SQ. M.
GARAGE	1,146 SQ. FT.	106.47 SQ. M.
TOTAL	6,020 SQ. FT.	559.28 SQ. M.

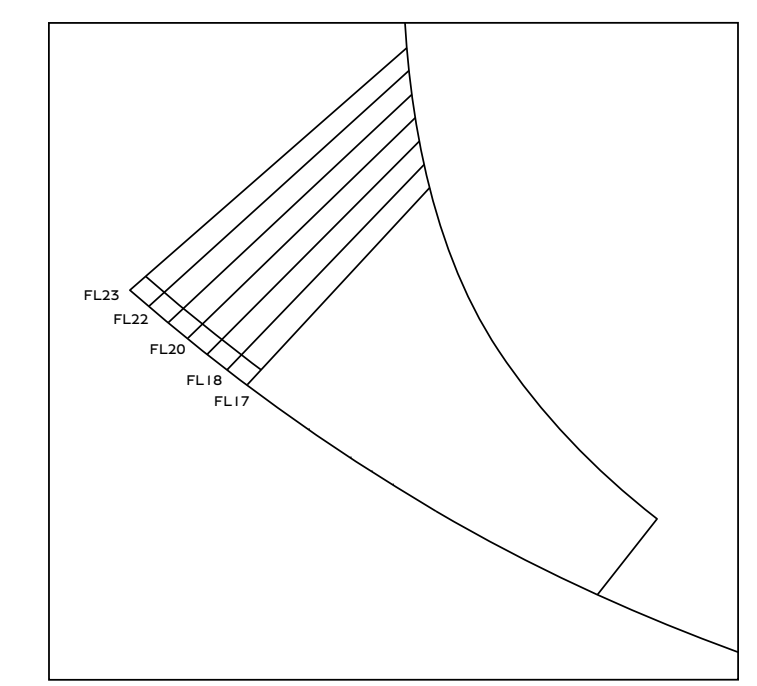
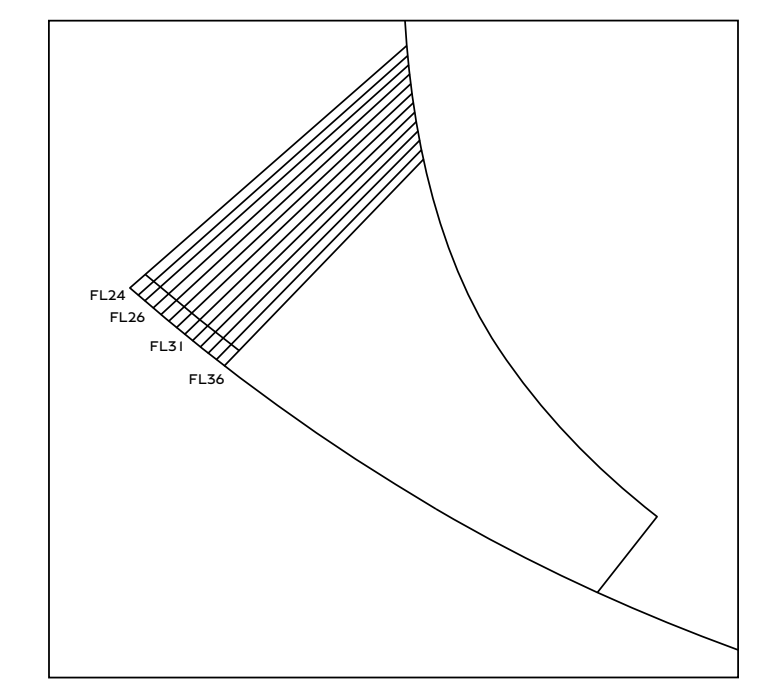

TERRACE AREA VARIES BY FLOOR

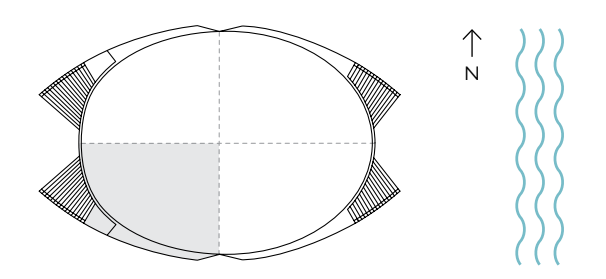

LINE 04

NORTH/WEST CORNER

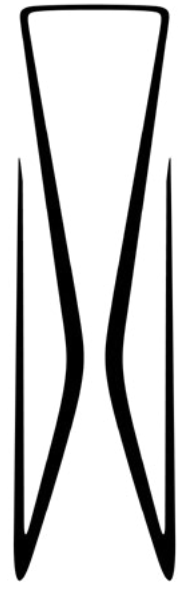

B
BENTLEY
RESIDENCES

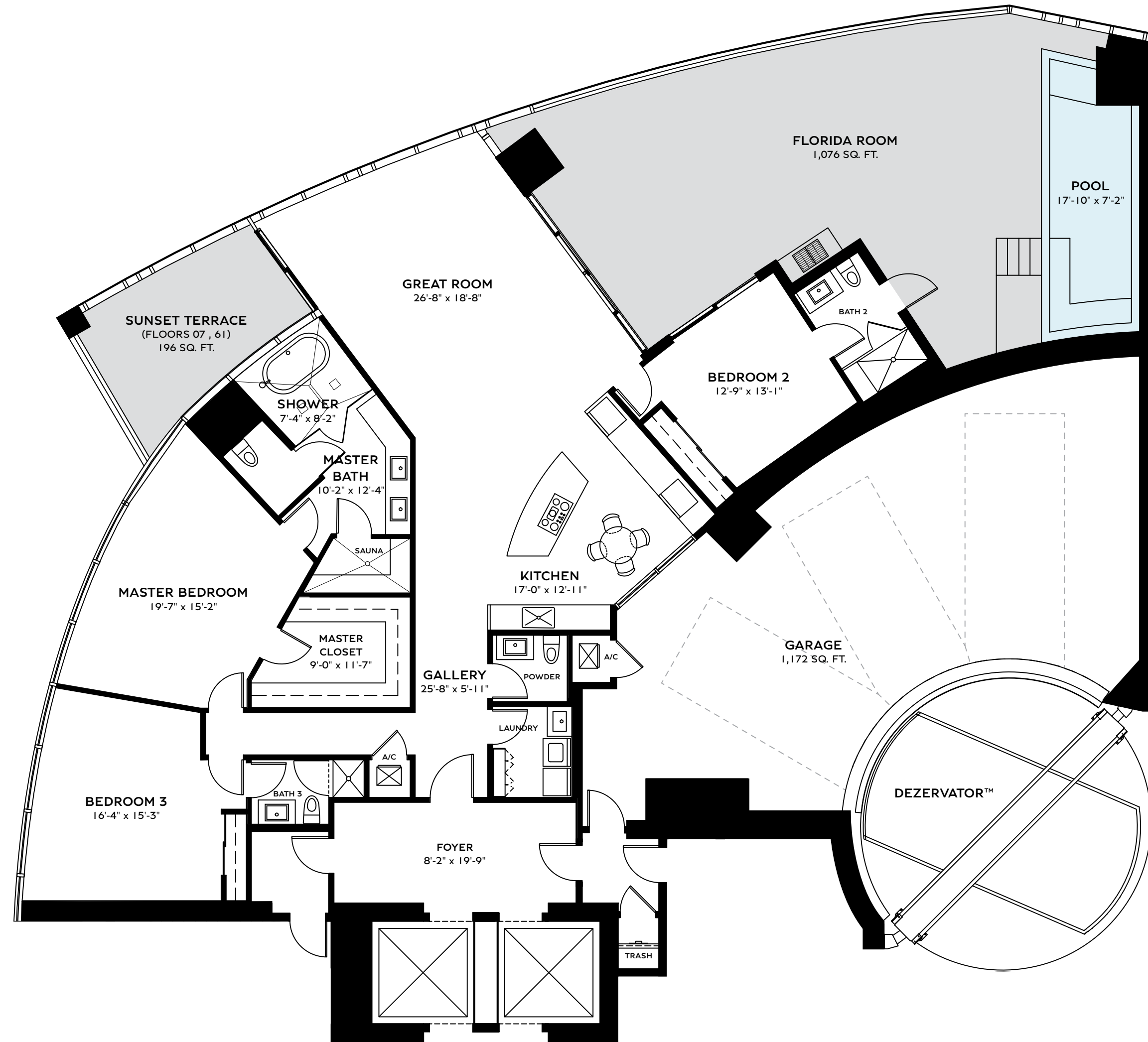

LINE 04
RESIDENCE BACALAR
3 BEDS | 3.5 BATHS

FLOORS 07 , 61

INTERIOR	2,835 SQ. FT.	263.38 SQ. M.
BALCONY	1,268 SQ. FT.	117.80 SQ. M.
GARAGE	1,172 SQ. FT.	108.88 SQ. M.
TOTAL	5,275 SQ. FT.	490.06 SQ. M.

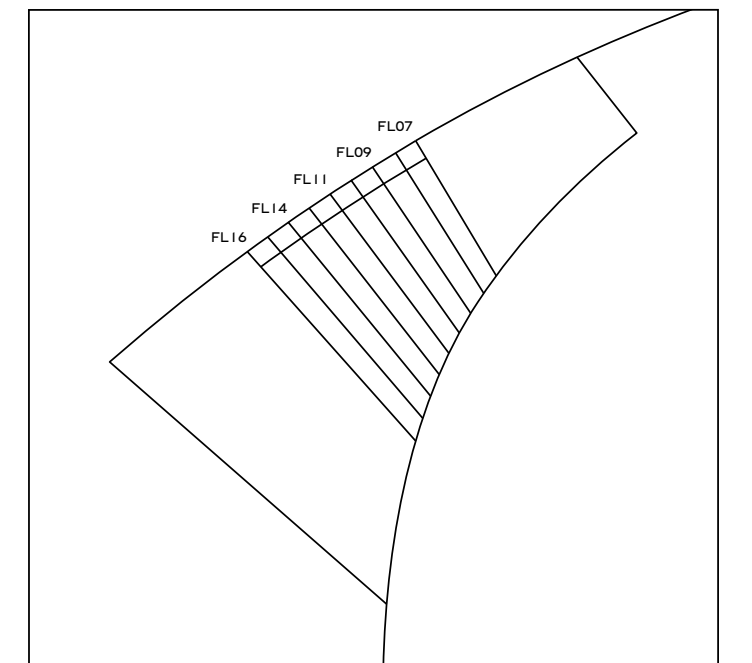
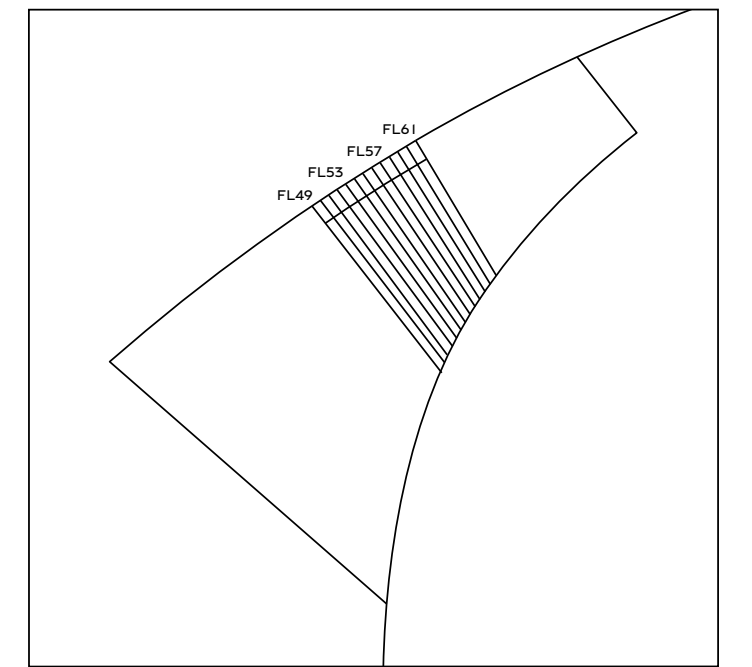

TERRACE AREA VARIES BY FLOOR

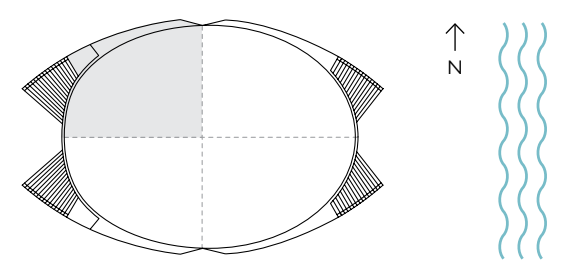

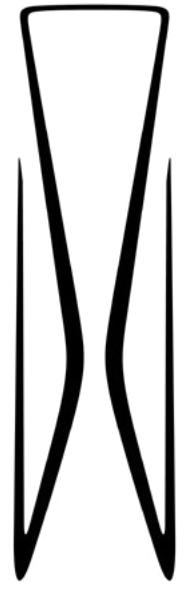

B
BENTLEY
RESIDENCES

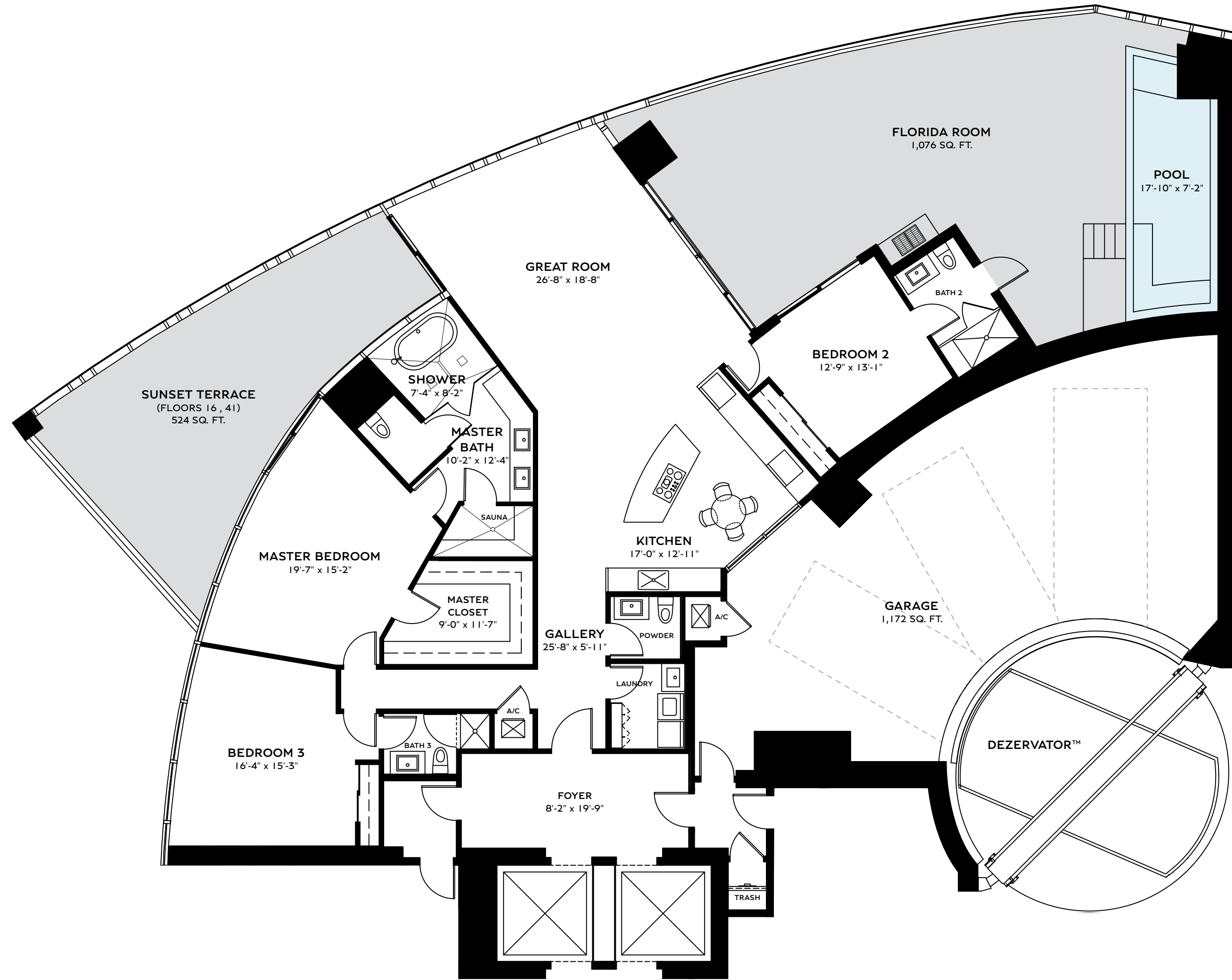

LINE 04
RESIDENCE BACALAR
3 BEDS | 3.5 BATHS

FLOORS 16, 41

INTERIOR	2,835 SQ. FT.	263.38 SQ. M.
BALCONY	1,596 SQ. FT.	148.27 SQ. M.
GARAGE	1,172 SQ. FT.	108.88 SQ. M.
TOTAL	5,603 SQ. FT.	520.54 SQ. M.

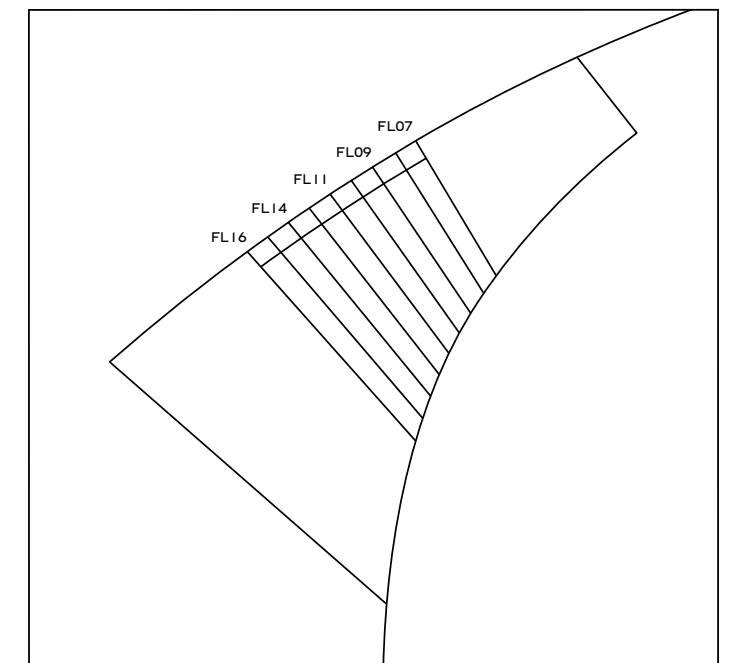
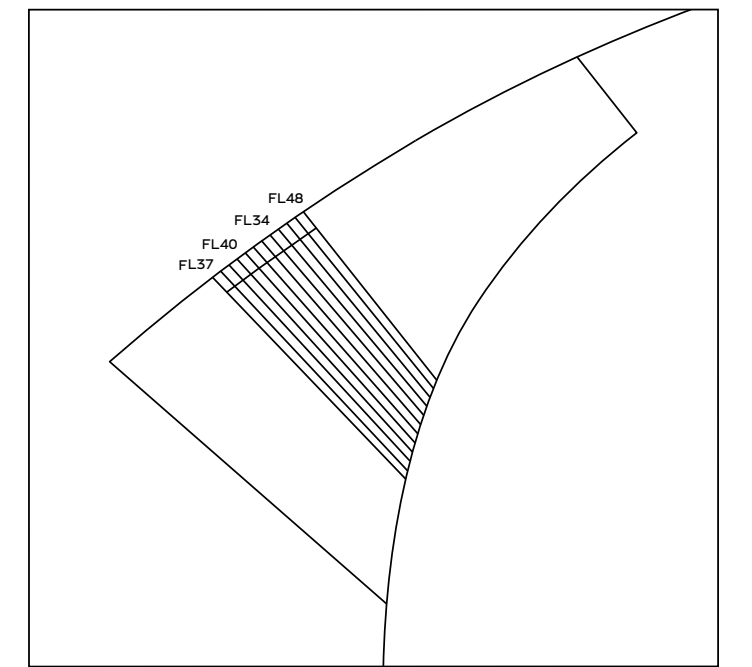

TERRACE AREA VARIES BY FLOOR

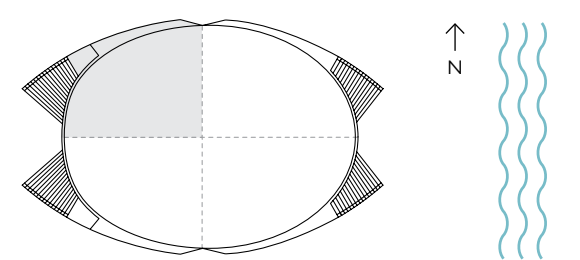

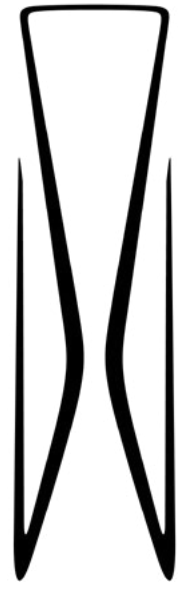

B
BENTLEY
RESIDENCES

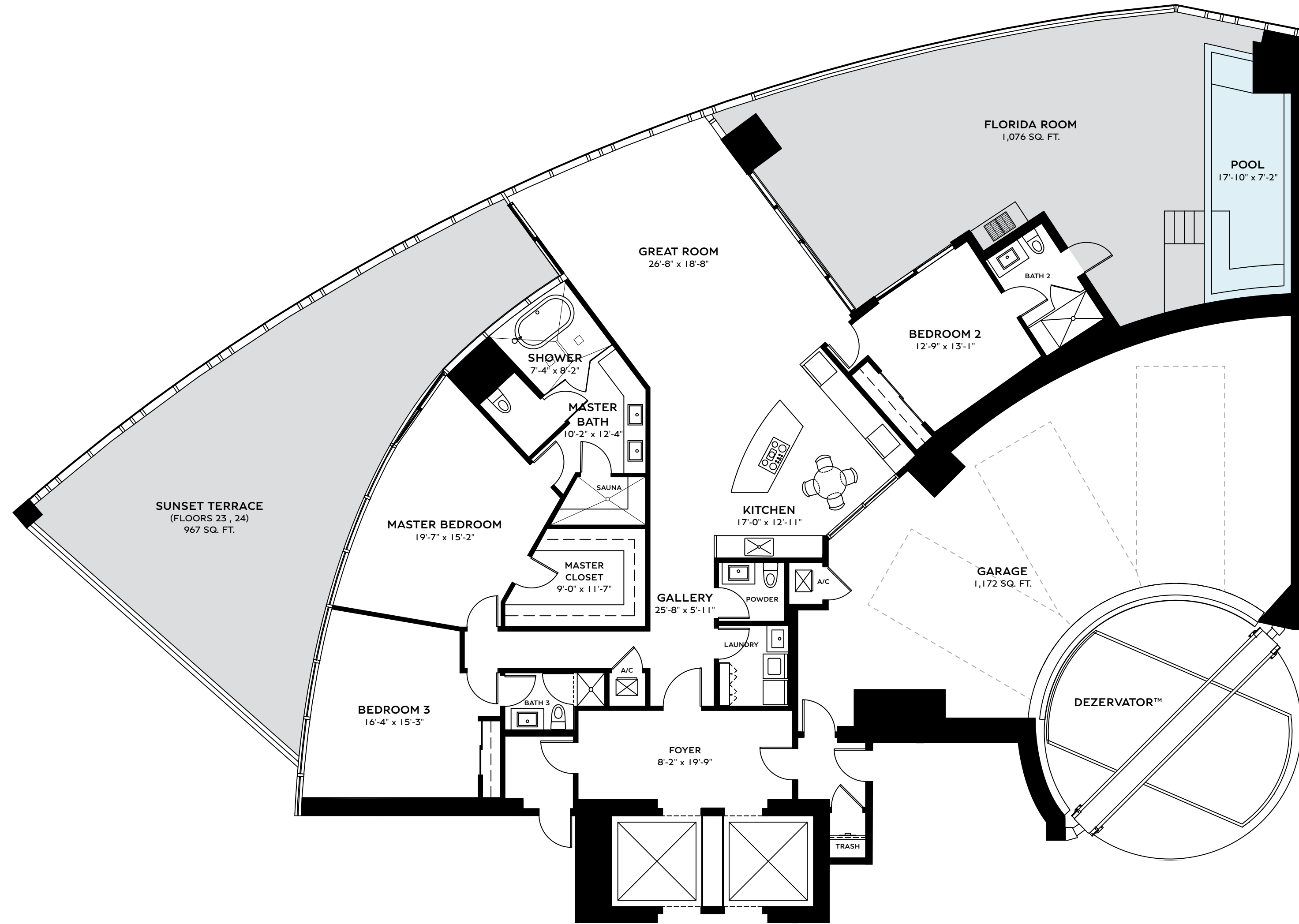

LINE 04
RESIDENCE BACALAR
3 BEDS | 3.5 BATHS

FLOORS 23 , 24

INTERIOR	2,835 SQ. FT.	263.38 SQ. M.
BALCONY	2,039 SQ. FT.	189.43 SQ. M.
GARAGE	1,172 SQ. FT.	108.88 SQ. M.
TOTAL	6,046 SQ. FT.	561.69 SQ. M.

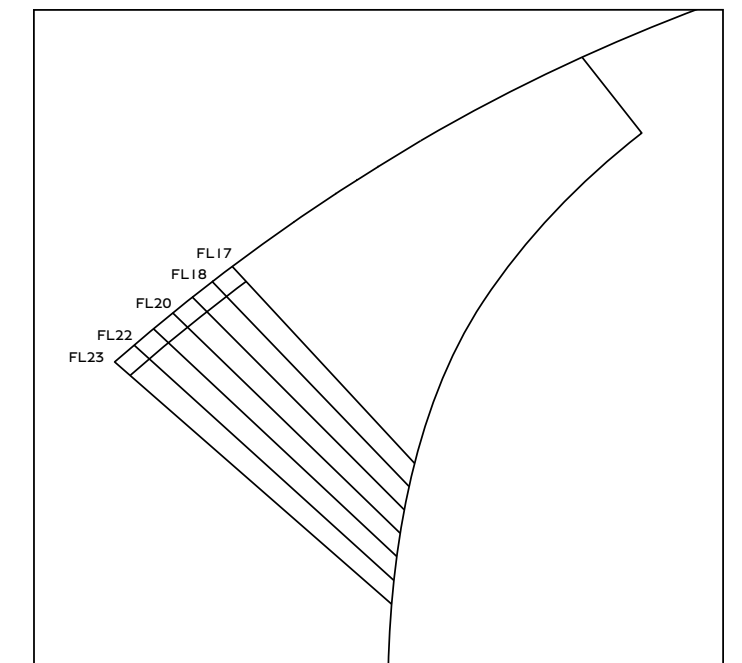
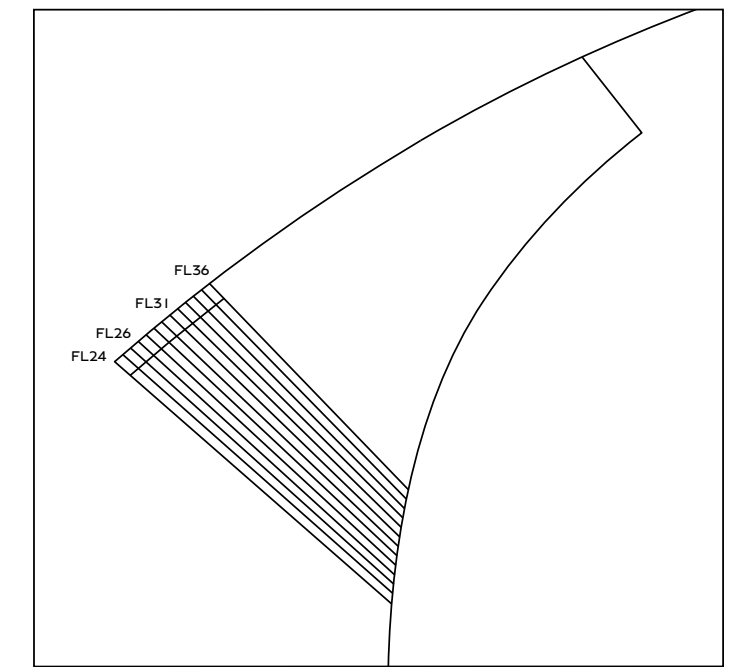

TERRACE AREA VARIES BY FLOOR

